

NON-CORROSIVE

NON-MAGNETIC

LIGHTWEIGHT

# Plastic bearings that revolve around your needs.

FROM THE JILSON GROUP

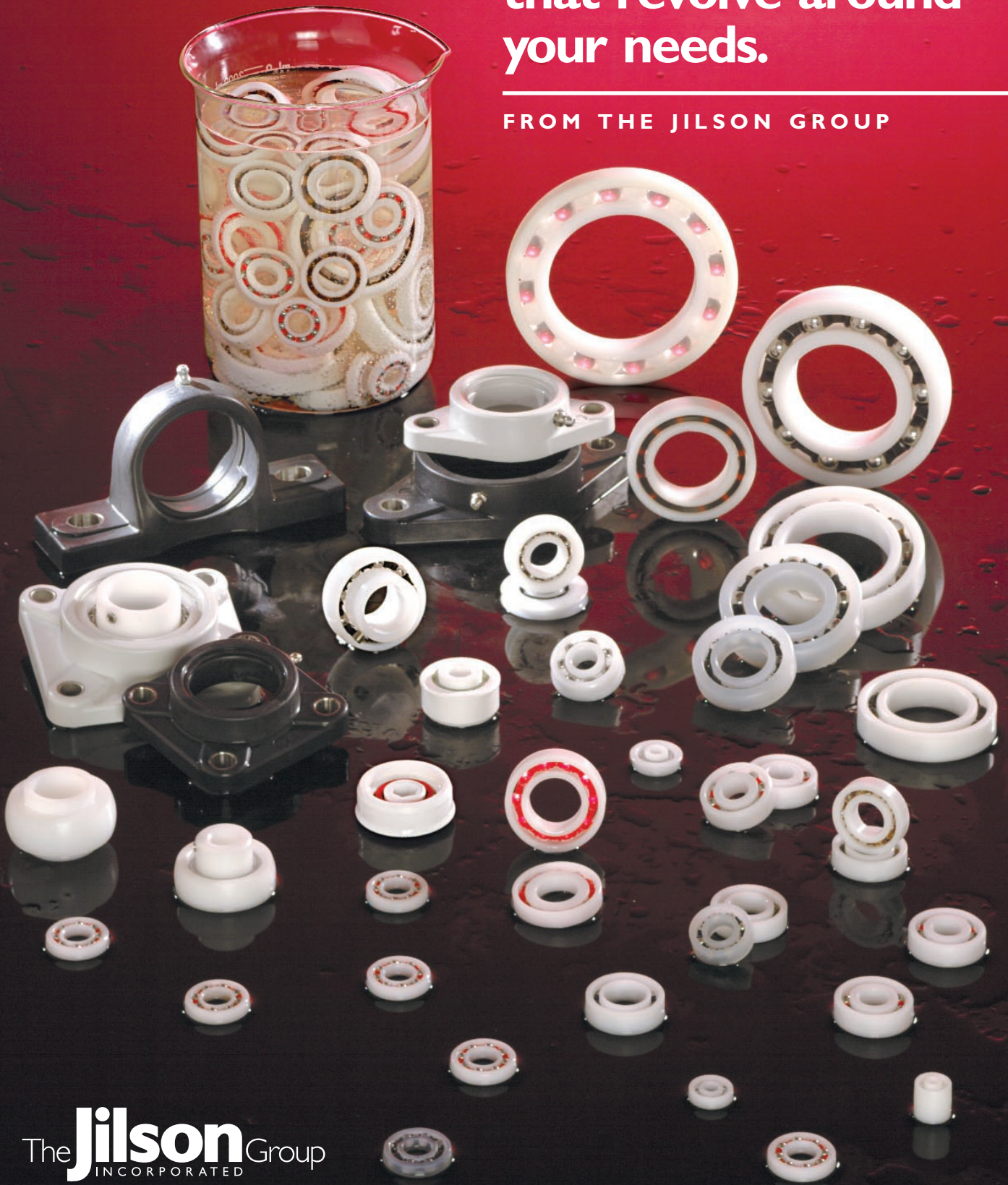

The **Jilson** Group  
INCORPORATED

# Plastic bearings that revolve around your needs

At Jilson, we go to extremes to make things move. As suppliers of the highest quality plastic bearings and housings, we offer the largest selection of in-stock items and the ability to custom fabricate to your exact specifications – in quantities as low as one to over one million!

## A perfect fit

Since 1974, our business has revolved around our customers' needs. We have literally thousands of standard and non-standard parts in-stock – in both inch and metric sizes. That means quick delivery – and less downtime for your equipment. Available inventory isn't the only thing that sets us apart. Our experience and reliability is unmatched in the industry – from finding the perfect replacement part...to custom engineering a new design for an OEM...to selecting the right material for your environment - our people have the knowledge to keep your equipment running smoothly.

## Not all bearings are created equal

It takes tough bearings to withstand a wet, corrosive environment – and we've got 'em! Our plastic bearings are lightweight and will go where no conventional bearing can. Jilson bearings are engineered using materials specially matched to your application, to keep your equipment running at optimal performance.

When combined with stainless steel or non-metallic balls, made of polymer or glass, they are completely non-magnetic. A great alternative when magnetic distortion must be avoided.

## Self-Lubricating = Maintenance Free!

Jilson's plastic ball bearings need no lubrication. They are self-lubricating when dry, and when submersed in liquids, they are lubricated by that medium. These bearings are a great solution for those areas hard to reach, inaccessible for lubrication or for areas that need to be free of contamination, such as food processing.

The **Jilson** Group  
INCORPORATED

**Cage Materials:\***

- Acetal
- Kynar
- Nylon
- Polyester
- Polyphenylene Sulphide
- Polypropylene
- Teflon
- \* Full Complement available

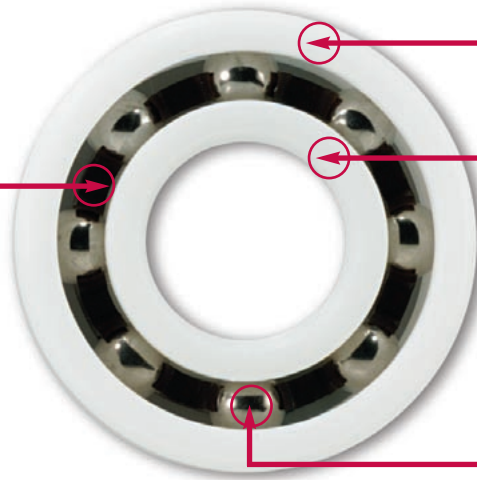

**Race Materials:**

- Acetal (POM)
- Kynar (PVDF)
- Polyester (PETP)
- Polyethylene (PE)
- Polyphenylene Sulphide (PPS)
- Polypropylene (PP)
- Teflon (PTFE)
- UHMW

**Ball Materials:**

- Acetal
- Borosilicate Glass
- Ceramic
- Glass
- Nylon
- Polypropylene
- SS 316-420

**APPLICATIONS†**

	Radial	Insert	Housings	Conveyor	Thrust	Special
Appliances	■				■	■
Automotive	■				■	■
Chemical and Electroplating	■	■	■			■
Conveyors and Material Handling	■	■	■	■		■
Data Processing Industry	■			■		■
Exercise Equipment		■	■	■		■
Food and Beverage Industries	■	■	■	■	■	■
Food Processing	■	■	■	■	■	■
Marine	■	■	■			■
Medical Equipment	■					■
Navigation	■					■
Outdoor Applications	■	■	■	■	■	■
Packaging Machinery	■	■	■	■		■
Paint, Ink and Dye Industries	■	■	■	■		■
Paper Industry	■	■	■	■		■
Pharmaceutical Industries	■	■	■			■
Photographic Film and Print Processing	■	■	■			■
Textile Industry	■			■		■
Water Treatment	■					■

†Applications above serviced, but *not* limited to only these.

Fig 1: Load vs speed

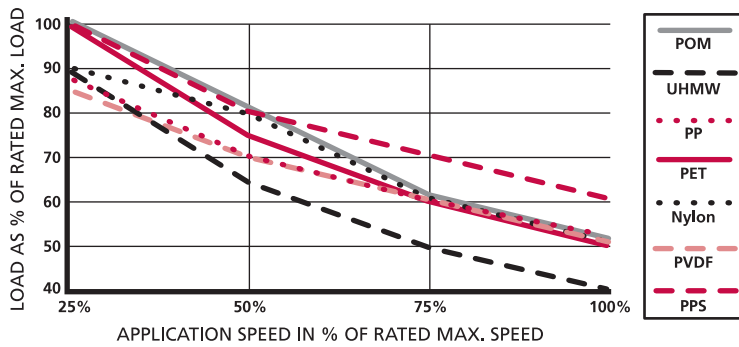

Fig 2: Capacity vs temperature

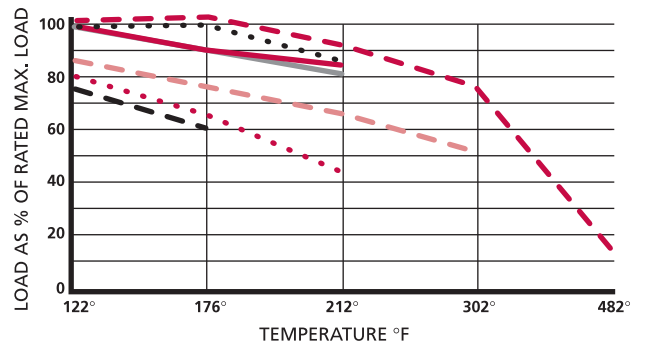

Fig 3: Continuous operation temperature

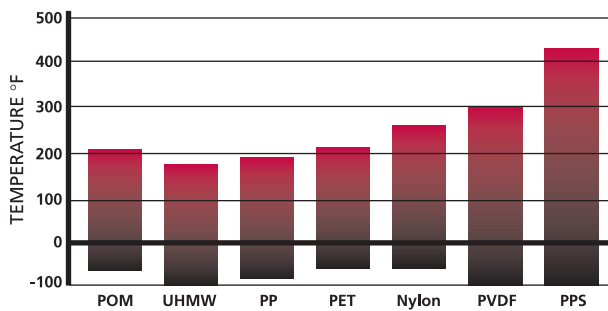
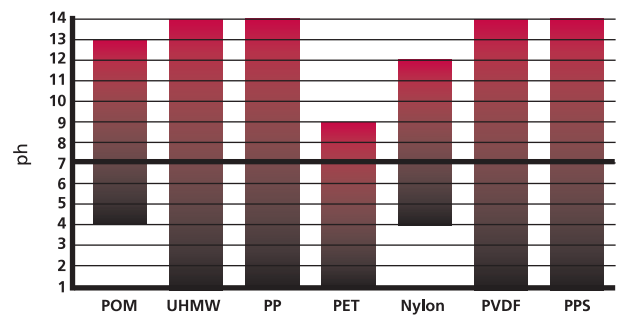

Fig 4: Acceptable ph range



CHEMICAL RESISTANCE

	ACETAL	KYNAR	NORYL	NYLON	PBT	PEIP	POLYETHYLENE	POLYPROPYLENE	PVC	TEFLON	UHMW	CARBON STEEL	CERAMIC	GLASS	SS316
ACETIC ACID, 20%	D	A	A	D	A	A	B	A	B	A	B	C	A	A	A
AMMONIUM NITRATE	C	A	A	D	B	A	B	A	A	A	B	D	A	A	A
AMMONIUM SULFATE	B	A	A	D	B	A	B	A	A	A	B	C	A	A	B
CHLORINE WATER	C	A	C	D	A	B	B	D	A	A	B	O	A	A	D
ETHYLENE GLYCOL	A	A	A	O	O	A	B	A	A	A	B	C	A	A	B
MAGNESIUM NITRATE	A	A	A	A	A	A	B	A	A	A	B	O	A	A	A
POTASSIUM BICARBONATE	C	A	A	A	A	A	B	A	A	A	B	O	A	A	B
POTASSIUM CARBONATE	B	A	A	A	A	A	B	A	A	A	B	B	A	A	B
POTASSIUM SULFATE	B	A	A	C	B	A	B	A	A	A	B	B	A	A	B
SODIUM CHLORIDE	A	A	A	A	A	A	B	A	A	A	B	C	A	A	B
SODIUM HYDROXIDE, 20%	D	A	A	A	B	A	B	A	A	A	B	O	D	A	A
SODIUM HYDROXIDE, 50%	D	D	A	A	C	B	C	A	A	A	C	O	D	B	A
COPPER CYANIDE	B	A	A	A	B	O	B	A	A	A	B	O	A	A	A
GOLD MONOCYANIDE	A	A	O	O	O	O	O	O	O	O	O	O	A	A	A
NICKEL CHLORIDE	B	A	A	A	A	A	B	A	A	A	B	O	A	A	B
NICKEL SULFATE	B	A	A	A	A	A	B	A	A	A	B	D	A	A	B
SILVER BROMIDE	C	A	A	O	B	O	O	O	O	O	O	O	O	B	B
SILVER NITRATE	C	A	A	A	A	A	B	A	A	A	B	C	A	A	B
ZINC CHLORIDE	C	A	A	A	A	A	B	A	A	A	B	C	A	A	B
ZINC HYDROSULPHITE	C	A	A	O	O	O	O	O	O	O	O	O	A	A	A
ZINC HYDROSULPHATE	C	A	A	A	B	A	B	A	C	A	B	D	A	A	A
ZINC SULFATE	C	A	A	A	A	A	B	A	C	A	B	D	A	A	A

SYMBOL IDENTIFICATION: A = Excellent, B = Good, C = Moderate effect (use under limited conditions), D = Not recommended, O = Unknown



- **Special Materials**
- **High Temperature Applications**
- **Large OD's**
- **Mix & Match**
- **Engineering Capabilities**
- **Diversity**
- **Problem Solvers**

If what you need is not standard or available from our stock, we'll create the perfect fit for your application, a part custom designed to your specifications. Once we have developed your unique product, we can stock an inventory for quick turnaround on re-orders. Whether it's a special size, particular environment, material or design – extended races, flanged bearings, clamping features (integrated into one bearing), components (where a part is manufactured around the bearing), or contoured races – our engineers will meet your needs.

Consider integrating the bearing as a component of your finished part – not only will you be assured of a perfect fit, but by reducing your number of components (SKU's), you can save money, too!



# RADIAL BALL BEARINGS: METRIC & INCH

All sizes listed are in stock!

## METRIC SIZE BEARINGS

- For Polypropylene (PP) races, reduce load capacity by 15%
- For Polyethylene (PE) races, reduce load capacity by 20%

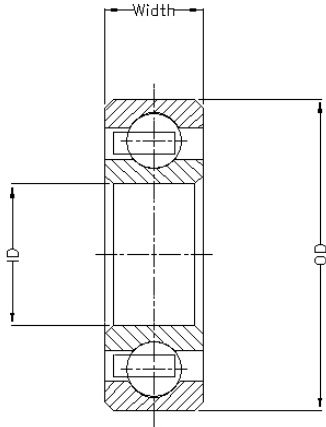

PART NUMBER	DIMENSIONS (MM)			RADIAL LOAD** CAPACITY (LB)		MAX RPM IN AIR
	I.D.	O.D.	WIDTH	STATIC	DYNAMIC	
00607	7	19	6	9	13	2600
00608	8	22	7	12	17	2200
00609	9	24	7	13	19	2050
00623	3	10	4	6	10	4500
00624	4	13	5	9	13	3600
00625	5	16	5	10	14	3050
00626	6	19	6	11	15	2600
00627	7	22	7	12	17	2200
00629	9	26	8	15	22	1900
06000	10	26	8	19	28	1900
06001	12	28	8	24	35	1750
06002	15	32	9	28	42	1550
06003	17	35	10	37	53	1400
06004	20	42	12	44	66	1200
06005	25	47	12	52	79	1050
06006	30	55	13	82	93	900
06007	35	62	14	70	105	800
06008	40	68	15	77	114	750
06009	45	75	16	84	123	650
06010	50	80	16	86	128	600
06011	55	90	18	88	132	550
06012	60	95	18	92	141	500
06013	65	100	18	97	147	475
06014	70	110	20	101	156	450
06015	75	115	20	105	158	420
06016	80	125	22	110	165	400
06200	10	30	9	28	37	1650
06201	12	32	10	33	48	1550
06202	15	35	11	37	55	1400
06203	17	40	12	48	70	1250
06204	20	47	14	59	92	1050
06205	25	52	15	70	105	950
06206	30	62	16	79	121	800
06207	35	72	17	90	136	700
06208	40	80	18	97	145	625
06209	45	85	19	103	158	580
06210	50	90	20	119	169	550
06211	55	100	21	130	180	500
06212	60	110	22	138	194	450
06300	10	35	11	42	61	1400
06301	12	37	12	48	68	1300
06302	15	42	13	57	81	1200
06303	17	47	14	66	99	1050
06304	20	52	15	77	116	950
06305	25	62	17	88	132	725
06306	30	72	19	101	154	675
06307	35	80	21	108	165	600
06308	40	90	23	114	180	550
06309	45	100	25	119	198	500
16002	15	32	8	28	41	1500
16003	17	35	8	35	53	1400
16004	20	42	8	42	64	1150
16005	25	47	8	46	68	1050
16006	30	55	9	53	81	900
16007	35	62	9	64	94	800
16008	40	68	9	66	99	750
16009	45	75	10	72	110	650
16010	50	80	10	77	110	600
16011	55	90	11	81	116	550
16012	60	95	11	88	125	500
16013	65	100	11	92	110	450
16014	70	110	13	99	141	400
16015	75	115	13	103	147	350
16016	80	125	14	110	158	300

\*\* Load ratings based on Acetal Races

# RADIAL BALL BEARINGS: METRIC & INCH

All sizes listed are in stock!



Jilson's plastic bearings are corrosion-resistant, self-lubricating and non-magnetic. We stock a full line of radial ball bearings in both standard inch and metric sizes – including single and double row bearings. Special and custom bearings are also available.

## INCH SIZE BEARINGS

- For Polypropylene (PP) races, reduce load capacity by 15%
- For Polyethylene (PE) races, reduce load capacity by 20%

PART NUMBER	DIMENSIONS (INCHES)			RADIAL LOAD** CAPACITY (LB)		MAX RPM IN AIR
	I.D.	O.D.	WIDTH	STATIC	DYNAMIC	
R03	3/16	1/2	.156	8	12	3050
R04	1/4	5/8	.196	12	26	2352
R04A	1/4	3/4	7/32	12	26	2352
R04B	1/4	3/4	.156	12	26	2352
R06	3/8	7/8	7/32	33	42	1600
R06A	3/8	7/8	9/32	33	42	1600
R08	1/2	1-1/8	1/4	43	55	1142
R08A	3/8	1-1/8	3/8	43	55	1142
R10	5/8	1-3/8	9/32	48	69	1069
R10A	5/8	1-3/8	3/8	48	69	1069
R10B	5/8	1-3/8	7/16	48	69	1069
R12	3/4	1-5/8	5/16	52	88	840
R16	1.0	2.0	1/2	77	105	729

## TOLERANCE TABLES

When installing Jilson bearings, a press fit on the I.D. or O.D. is recommended.

For press fit on I.D., shaft should be 0.001" larger than bearing.

For O.D. press fit, the housing bore should be 0.001" smaller than bearing O.D.

A press fit on the I.D. and O.D. may cause bearing failure due to diminished radial clearance.

NOTE: These tolerances are for normal production based on bearings with Acetal races. Other material tolerances may differ.

INSIDE DIAMETER			
INCH SERIES		METRIC SERIES	
DIMENSIONS	TOLERANCES	DIMENSIONS	TOLERANCES
up to .624"	± .0015"	up to 25 mm	± .03 mm
.625 to 1.000"	± .002"	26 to 80 mm	± .05 mm

OUTSIDE DIAMETER			
INCH SERIES		METRIC SERIES	
DIMENSIONS	TOLERANCES	DIMENSIONS	TOLERANCES
up to .999"	± .002"	up to 47 mm	± .05 mm
1.000 to 1.999"	± .003"	52 to 125 mm	± .07 mm
2.000 to 3.000"	± .004"		

INCH SERIES	METRIC SERIES
All Sizes ±.005"	All Sizes 0 to -0.1 mm

\*\* Load ratings based on Acetal Races

## INSERT BEARINGS

Jilson's self-aligning Insert Bearings are the perfect replacement for typical self-aligning metal insert bearings. Available in non-corrosive and non-metallic materials, they perform equally well in both thermoplastic and metal housings.

Jilson Insert Bearings are available in various combinations of plastic materials and balls and are supplied open with options for one or two shields. Stainless steel and chrome steel insert bearings available upon request.



### INCH SIZE INSERT BEARINGS

- For Polypropylene (PP) races, reduce load capacity by 15%
- For Polyethylene (PE) races, reduce load capacity by 20%
- Some bearings available with single or double enclosures (i.e. shields)

PART NUMBER	DIMENSIONS (INCHES)		DIMENSIONS (INCHES)				RADIAL LOAD** CAPACITY (LB)		MAX RPM IN AIR
	d	D	Bi	Be	m	n	STATIC	DYNAMIC	
N08	1/2	1.850	1.220	.669	.720	.500	70	105	1050
N10	5/8	1.850	1.220	.669	.720	.500	70	105	1050
N12	3/4	1.850	1.220	.669	.720	.500	70	105	1050
N14	7/8	1.850	1.220	.669	.720	.500	70	105	1050
N15	15/16	2.047	1.220	.669	.720	.500	70	105	1050
N16	1.0	2.047	1.343	.669	.776	.563	80	115	950
N17	1-1/16	2.441	1.500	.748	.874	.626	90	140	800
N18	1-1/8	2.441	1.500	.748	.874	.626	90	140	800
N19	1-3/16	2.441	1.500	.748	.874	.626	90	140	800
N20	1-1/4	2.441	1.500	.748	.874	.626	105	160	700

### METRIC SIZE INSERT BEARINGS

- For Polypropylene (PP) races, reduce load capacity by 15%
- For Polyethylene (PE) races, reduce load capacity by 20%
- Some bearings available with single or double enclosures (i.e. shields)

PART NUMBER	DIMENSIONS (MM)		DIMENSIONS (MM)				RADIAL LOAD** CAPACITY (LB)		MAX RPM IN AIR
	d	D	Bi	Be	m	n	STATIC	DYNAMIC	
M10	10	47	31	17	18	13	70	105	1050
M12	12	47	31	17	18	13	70	105	1050
M15	15	47	31	17	18	13	70	105	1050
M17	17	47	31	17	18	13	70	105	1050
M20	20	47	31	17	18	13	70	105	1050
M25	25	60	34	17	20	14	80	115	950
M30	30	62	38	19	22	16	90	140	800
M35	35	72	43	20	25	18	105	160	700

\*\* Load ratings based on Acetal Races

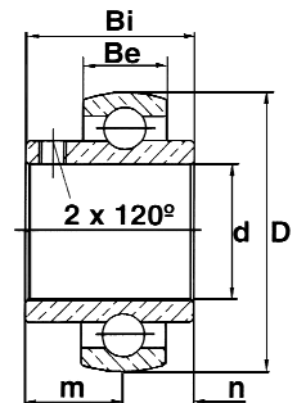



Jilson Bearing Housings – made of high-grade solid PBT thermoplastic polyester – are the durable, corrosion-resistant replacement for conventional metal housings. These maintenance-free housings have excellent mechanical strength, stiffness and dimensional stability – and they’ll never rust or corrode.

Yet they can be cleaned or hosed down with hot water and will operate at temperatures up to 280°F.\*

Compare our smooth surfaces with the rough surfaces on metal housings and you’ll see how those surfaces can harbor dirt, mold or bacteria. There’s no plating or coating to chip or peel and their solid construction means no vulnerable parts to expose.

Jilson Housings can be supplied with steel or plastic ball bearings, or plastic bushings – they’re available in standard size units which accept standard-size insert ball bearings. Plastic bearings and bushings are self-lubricating and do not require lubricant.

Housings can be ordered with or without bushings. Bushings are only available in plastic. Standard housing color is black. Other colors are available.

\* NOTE: 280°F is the maximum operating temperature range when steel insert bearings are used. Using plastic insert bearings will decrease the temperature range by approximately 10%.

<b>PART NUMBER</b>	<b>MATCHING INSERT BEARING</b>	<b>DIMENSIONS INCHES</b>										
--------------------	--------------------------------	--------------------------	--	--	--	--	--	--	--	--	--	--

**PILLOW BLOCK**

	<b>MM (OD)</b>	<b>INCH (OD)</b>	<b>h</b>	<b>a</b>	<b>e</b>	<b>b</b>	<b>S1</b>	<b>S2</b>	<b>g</b>	<b>w</b>	<b>Bi</b>	<b>n</b>
PPL 204	47	1.8504	1-5/16	5	3-3/4	1-1/2	7/16	9/16	9/16	2-9/16	1-7/32	1/2
PPL 205	60	2.0472	1-7/16	5-1/2	4-1/8	1-1/2	7/16	9/16	19/32	2-25/32	1-11/32	9/16
PPL 206	62	2.4409	1-11/16	6-3/8	4-11/16	1-13/16	9/16	23/32	11/16	3-9/32	1-1/2	5/8
PPL 207	72	2.8346	1-7/8	6-9/16	5	1-7/8	17/32	23/32	23/32	3-11/16	1-11/16	11/16

**4 BOLT FLANGE**

	<b>MM (OD)</b>	<b>INCH (OD)</b>	<b>a</b>	<b>e</b>	<b>g</b>	<b>l</b>	<b>S</b>	<b>z</b>	<b>i</b>	<b>Bi</b>	<b>n</b>
FPL 204	47	1.8504	3-3/8	2-1/2	1/2	1	7/16	1-3/8	19/32	1-7/32	1/2
FPL 205	60	2.0472	3-3/4	2-3/4	9/16	1-1/16	7/16	1-13/32	5/8	1-11/32	9/16
FPL 206	62	2.4409	4-1/4	3-9/32	9/16	1-7/32	7/16	1-21/32	3/4	1-1/2	5/8
FPL 207	72	2.8346	4-5/8	3-5/8	19/32	1-5/16	1/2	1-3/4	3/4	1-11/16	11/16

**2 BOLT FLANGE**

	<b>MM (OD)</b>	<b>INCH (OD)</b>	<b>a</b>	<b>e</b>	<b>b</b>	<b>g</b>	<b>l</b>	<b>S</b>	<b>z</b>	<b>i</b>	<b>Bi</b>	<b>n</b>
NFL 204	47	1.8504	4-7/16	3-17/32	2-3/8	7/16	1	7/16	1-5/16	19/32	1-7/32	1/2
NFL 205	60	2.0472	5-1/8	3-29/32	2-11/16	1/2	1-1/16	7/16	1-13/32	5/8	1-11/32	9/16
NFL 206	62	2.4409	5-13/16	4-19/32	3-5/32	1/2	1-7/16	7/16	1-9/16	23/32	1-1/2	5/8
NFL 207	72	2.8346	6-7/16	5-1/8	3-9/16	19/32	1-9/32	1/2	1-3/4	3/4	1-11/16	11/16

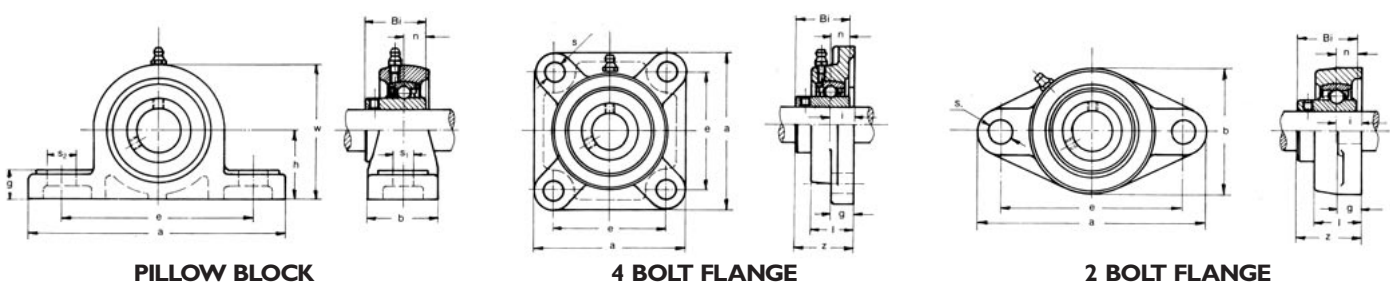

**PILLOW BLOCK**

**4 BOLT FLANGE**

**2 BOLT FLANGE**

## CONVEYOR BEARINGS

Jilson's non-corrosive line of Conveyor Bearings (End Cap Bearings) offers a quiet, low friction, no maintenance alternative. Designed as an easier fit to standard size tubes and rollers, they can be washed down and require no lubrication. Ratings are based on acetal races and stainless steel balls. Other materials are available.

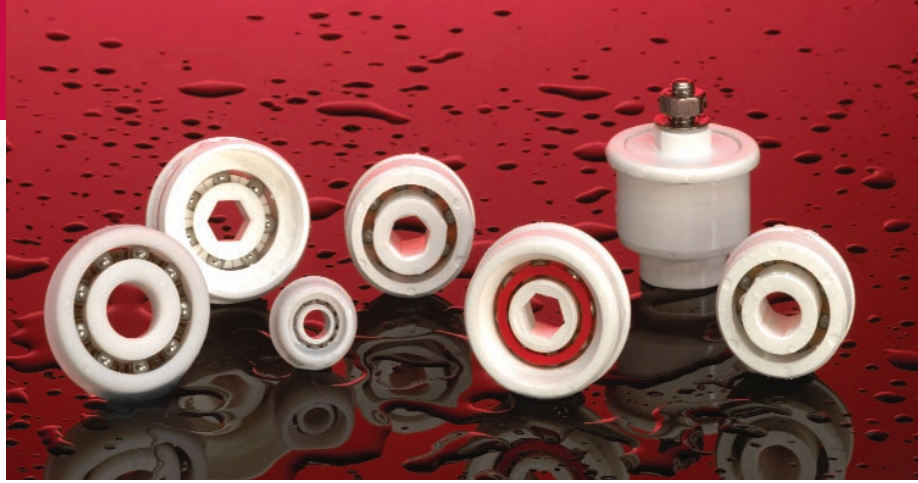

### CONVEYOR/ END CAP BEARINGS

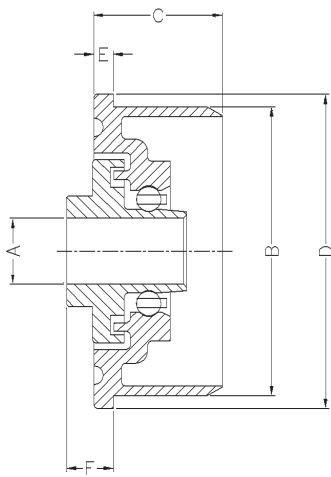

PART NUMBER	BORE (A)	ENGAGE O/D (B)	FLANGE O/D (D)	FLANGE WIDTH (E)	STAND OUT (F)	TUBE SIZE	LOAD CAPACITY ** (lbs)
EC312R-875	5/16"	.875-.878"	1.0"	.07"	.08"	1" x 16g STEEL/ALUM	30
EC312-1.00	5/16" hex	1.063"	1-5/16"	.18"	.175"	1" PVC (O.D. 1.315)	31
EC437-1.50	7/16" hex	1.50-1.504"	1.89"	.06"	1/8"	1-1/2" SCH. 80	50
EC437-1.60	7/16" hex	1.610-1.618"	1.89"	.18"	.12"	1-1/2" SCH. 40	50
EC437-1.625	7/16" hex	1.625-1.629"	1.89"	.18"	.12"	1-1/2" SCH. 40	50
EC437-1.780	7/16" hex	1.78"	1.86"	.10"	.12"	1.9" 16G STEEL/ALUM TUBE	80
EC437-2.00	7/16" hex	2.054-2.057"	2-5/16"	.07"	.10"	2.0" SCH. 40	80
EC500R-1.50	1/2"	1.50"	1.562"	.10"	.156"	1.9" SCH. 80	50

### ULTRA SEAL CONVEYOR/ END CAP BEARINGS

- Many of the items listed are available in polypropylene (PP) or with glass balls
- Other sizes available upon request (including metric sizes)
- Some sizes may require a minimum order

PART NUMBER	BORE (A)	ENGAGE O/D (B)	FLANGE O/D (D)	FLANGE WIDTH (E)	STAND OUT (F)	TUBE SIZE	LOAD CAPACITY ** (lbs)
EC312-1.60-US	5/16"	1.610-1.614"	1.85"	.16"	1/4"	1-1/2" SCH. 40	55
EC312-1.625-US	5/16"	1.626-1.63"	1.9"	.16"	1/4"	1-1/2" SCH. 40	55
EC312-2.00-US	5/16"	2.061-2.065"	2.36"	.16"	1/4"	2" SCH. 40	55

\*\* Load ratings based on Acetal Races

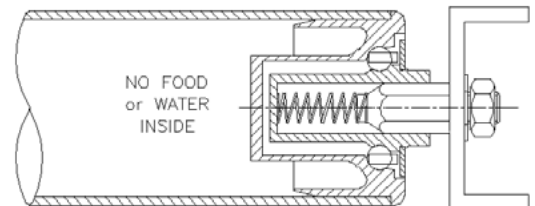

## THRUST BEARINGS

The Jilson one piece Thrust Ball Bearing assemblies accept greater axial thrust loads in one direction at moderate speeds with minimal radial load. Available in standard inch or metric sizes. All information based on acetal races with glass or stainless steel balls. Other materials and custom sizes are available.

### THRUST BALL BEARINGS

- For Polypropylene (PP) races, reduce load capacity by 15%
- For Polyethylene (PE) races, reduce load capacity by 20%

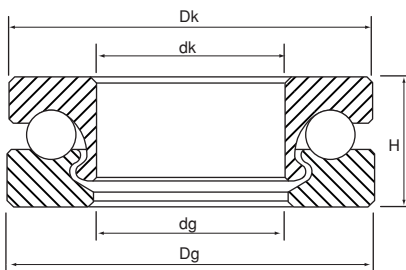

PART NUMBER	DIMENSIONS				H [mm]	LOAD** CAPACITY (KG)	MAX SPEED RPM
	dk [mm]	Dg [mm]	dg [mm]	Dk [mm]			
51100	10	24	11	23	9	20	600
51200	10	26	11	25	11	21	600
51101	12	26	13	25	9	32	540
51201	12	28	13	27	11	33	540
51102	15	28	16	27	9	50	500
51202	15	32	16	31	12	52	500
51103	17	30	18	29	9	57	480
51203	17	35	18	34	12	60	480
51104	20	35	21	34	10	160	460
51204	20	40	21	39	14	69	460
51105	25	42	26	41	11	71	410
51205	25	47	26	46	15	75	400
51106	30	47	31	46	11	76	400
51206	30	52	31	51	16	82	375
51107	35	52	36	51	12	81	390
51207	35	62	36	61	18	87	365
51108	40	60	41	59	13	89	375
51208	40	68	41	67	19	94	350
51109	45	65	46	64	14	95	360
51209	45	73	46	72	20	101	330

\*\* Load ratings based on Acetal Races

## POULTRY BEARINGS

The Jilson Poultry Bearings have been tried and tested for over 30 years. These corrosion resistant, self lubricating bearings can be washed down. Designed to fit all types of systems, these bearings offer a quiet, low friction part with proven performance.

### POULTRY BEARINGS

- \* For Johnson eviscerating.
- \*\* Minimum order quantity may apply.

Part Number	Overhead System	Color
R16PW-ASA-2.25EX	X348	Grey
R16PW-ASA-5/16EX	MEYN T-Track	Grey
R16PW-ASA-5/16EX w/Yoke	MEYN T-Track	Grey
R16PW-ASXS-3/8"	Johnson Pipe Track	Yellow
R16PW-ASX-3/8"	Johnson Pipe Track	Yellow
R16PW-ASX-5/16-2EX**	Linco System	Blue
R16PW-ASA-5/16**	Linco System	Blue



**We go to extremes to make things move.™**

20 Industrial Road, Lodi, NJ 07644-2608  
800-969-5400 • 973-471-2400 • Fax 973-471-3993  
[www.jilson.com](http://www.jilson.com) • [info@jilson.com](mailto:info@jilson.com)